

Zero Injection Smart Meter

Installation and Operation Manual

www.aforeenergy.com



Version: A00001-01

Afore

Afore New Energy Technology (Shanghai) Co., Ltd.

T 86-21-54326236 F +86-21-54326136 E info@aforeenergy.com

Ad Building 7, No.333 Wanfang Rd, Minhang District, Shanghai, China. 201112

Afore

Afore New Energy Technology (Shanghai) Co., Ltd.

Contents

1. About This Manual	1
2. Parameter.	1
3. Zero-injection Connection	2
4. Connect the Smart Meter to Single-phase System	5
4.1 System Diagram	5
4.2 Inverter Setting	6
4.3 Single-phase System Wiring Diagram	7
5. Single-phase Inverter Zero-Injection FAQ	7
6. Explanation of Smart Meter Display Content	9
7. Connect the Smart Meter to Three-phase System	10
7.1 System Diagram	10
7.2 Three-phase 3-25kW Inverter Setting	11
7.3 Three-phase 30-60kW Inverter Setting	12
7.4 Multiple Inverter System Connection Setting	14
7.5 Wiring Diagram	16
7.6 CT	17
7.7 Current Ratio Setting	17
8. Three-phase Inverter Zero-Injection FAQ	18
8.1 Three-phase 3-25kW Zero-Injection FAQ	18
8.2 Three-phase 30-60kW Zero-Injection FAQ	20
9. Explanation of Smart Meter Display Content	22
10. Trouble Shooting	23

1. About This Manual

Afore smart meter is an intelligent control device, which is designed for grid-connected inverters. Its main function is to measure the generation and consumption, transmit the data to the inverter through RS485 communication, to ensure that the generated power of the inverter is less or equal to the user's load. Achieve the purpose of no power feed into the grid.

This manual describes the installation, operation and maintenance of the following Afore Smart Meter.

For Single-phase System Application

SAPM-10kW

For Three-phase System Application

TAPM-50kW, TAPM-130kW

2. Parameter

Type	SAPM-10KW	TAPM-50KW	TAPM-130KW
Power (kW)	10	50	130
Max Power (kW)	18	55	150
Accuracy (%)	1	1	1
Rating voltage (V)	230	230/400	230/400
Voltage Range (V)	184-253	320-440	320-440
Rating Current (A)	50	72.5	200(MAX 5000)
Max Current (A)	80	80	220(MAX 5000)
Connection For Measurement (Hz)	Direct Connect	Direct Connect	Via CT(current transducers)
Frequency Range (Hz)	45-65	45-65	
Grid Type	L+N	3P+N	
Communication	RS485	RS485	
Dimmension (W,L,H , mm)	36 x 98 x 65	72 x 100 x 65	
IP	IP20		
Installation	35mm Rail		

a. Single-phase Smart Meter

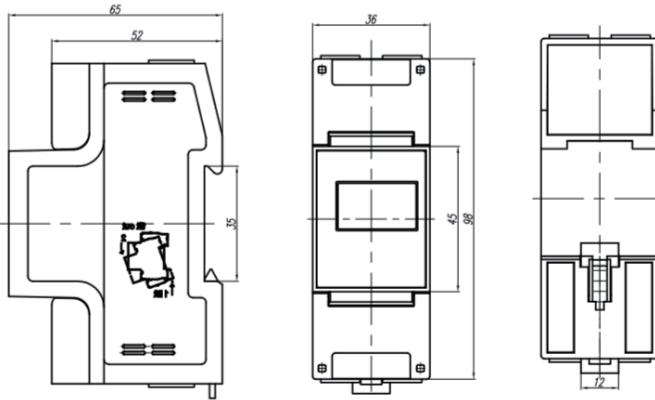

b. Three-phase Smart Meter

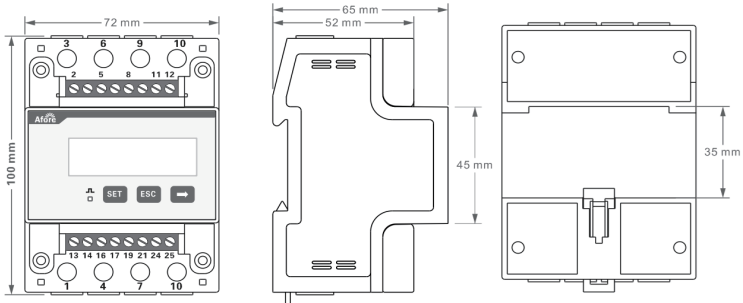

3. Zero-injection Connection



Note:

1. CAT5/CAT6 cable should be used between smart meter and inverter
Maximum length of cable less than 300m
2. Meter connection on the inverter
The meter needs to be connected to the inverter's Zero-injection port (RJ45 terminal).

RJ45 Pin order for single-phase inverter

568B Standard	
1. White green	5. White blue
2. Green	6. Orange
3. White orange	7. White brown
4. Blue	8. Brown



Zero-Injection Connector wiring for three-phase 3-25kW inverter

PIN	Assignment
1/2	RS485 B
3/4	RS485 A

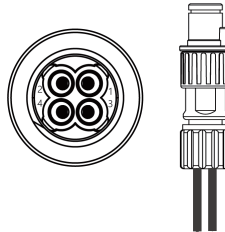

RJ45 Pin order for three-phase 30-60kW inverter

568B Standard	
1. White orange	5. White blue
2. Orange	6. Green
3. White blue	7. White brown
4. Blue	8. Brown



Note:

1. For single-phase inverter, please follow below pin order
 RS485A (Pin 7) to single-phase meter (Pin 24)
 RS485B (Pin 8) to single-phase meter (Pin 25)
2. For three-phase 3-25kW inverter, please follow below pin order
 RS485A (Pin 3 / 4) to three-phase meter (Pin 24)
 RS485B (Pin 1 / 2) to three-phase meter (Pin 25)
3. For three-phase 30-60kW inverter, please follow below pin order
 RS485A (Pin 1) to three-phase meter (Pin 24)
 RS485B (Pin 2) to three-phase meter (Pin 25)



Note:

The distance between the inverter and smart meter is suggested less than 100M. For the distance more than 100M, it needs to parallel a 120Ω resistor between 24A and 25B of the smart meter.

Single-phase Smart Meter

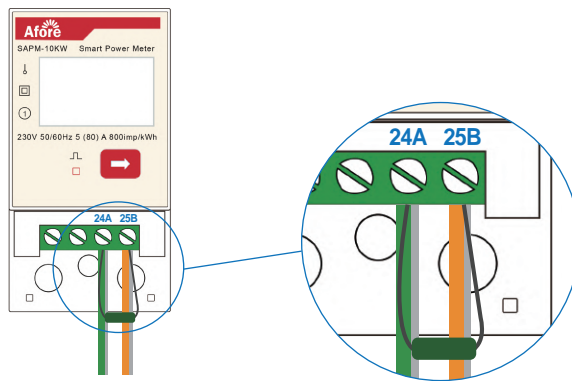

Three-phase Smart Meter

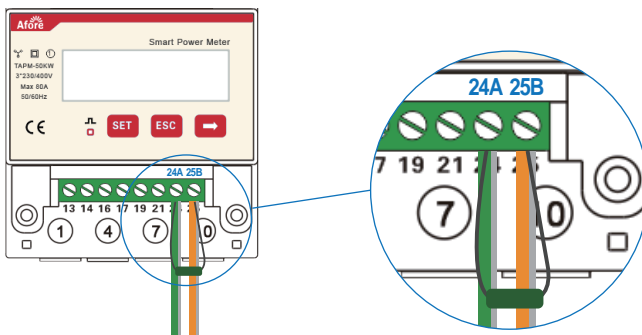

4. Connect the Smart Meter to Single-phase System

4.1 System Diagram

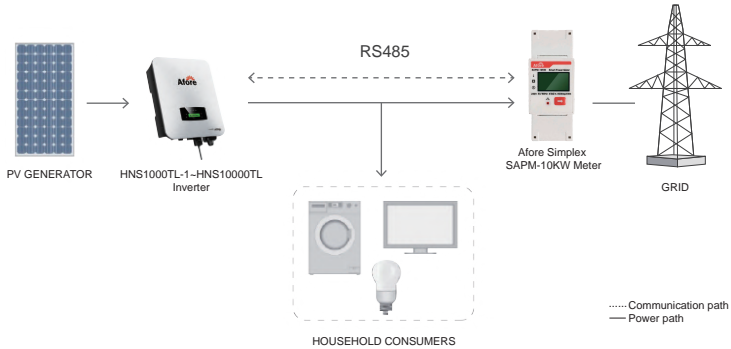

Note:

When the load exceeds 10kW, a CT needs to be added, see the figure below:

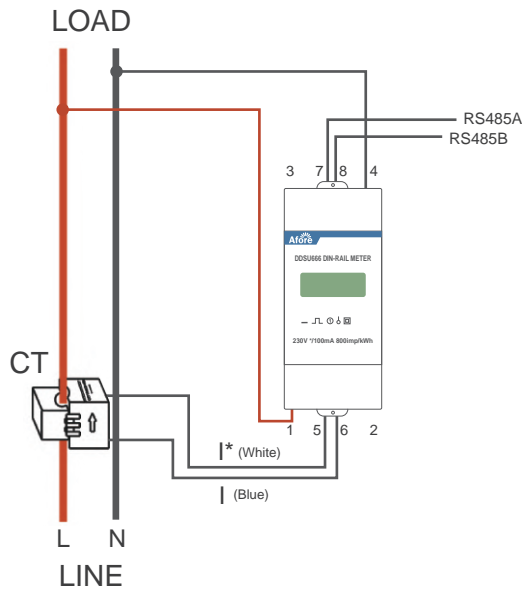

4.2 Inverter Setting

Step 1

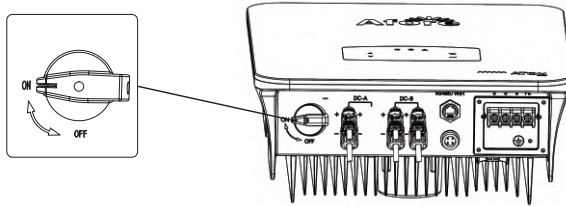

Step 2

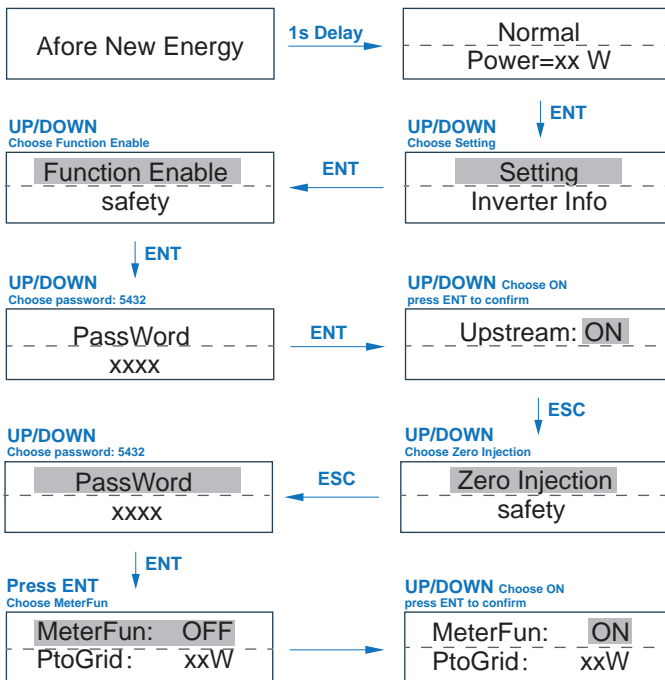

Step 3

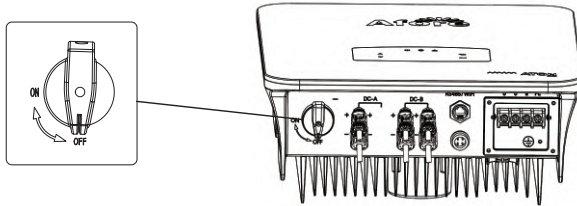

Note: After activate "Zero Injection" function, please restart the inverter.

4.3 Single-phase System Wiring Diagram

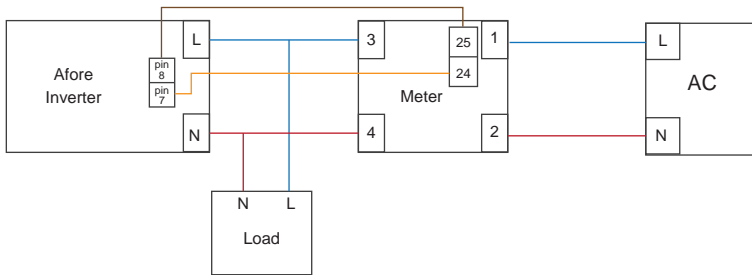

5. Single-phase Inverter Zero-Injection FAQ

a. After complete wiring between smart meter and inverter. The power P display on the smart meter will synchronize with inverter Pac display.

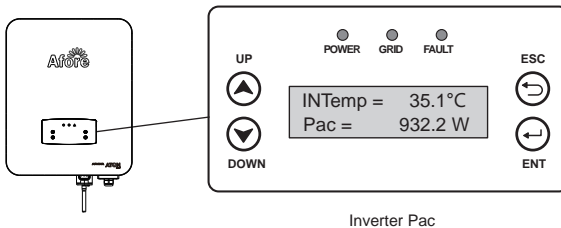

Inverter Pac

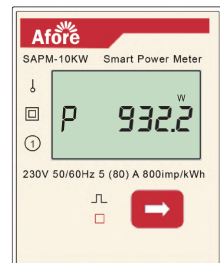

Single-phase Smart Meter

b. If the Zero-injection function is not activated or communication cable is not well connected, the power displayed on the inverter is $Pac=0W$.

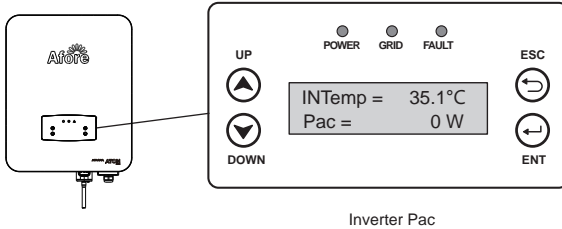

Inverter Pac

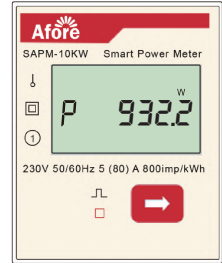

Single-phase Smart Meter

c. If the smart meter's pin order is incorrect wiring, the Smart Meter and the inverter Pac will display negative values.

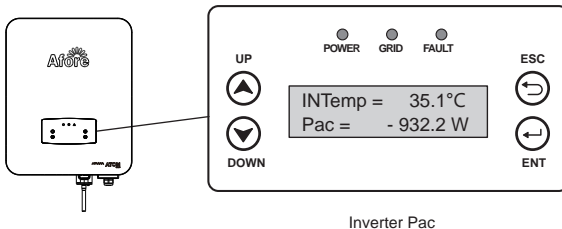

Inverter Pac

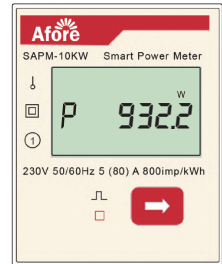

Single-phase Smart Meter



Note:









The button on the smart meter cannot be kept pressing for a long time, it can only be pressed intermittently, otherwise the meter will be locked.



Note:

Due to the fluctuation on the grid side, the data transition delay will occur between smart meter and inverter. And the values displayed on the smart meter and inverter will be different.

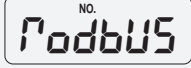
6. Explanation of Smart Meter Display Content

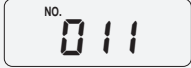
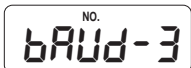
Page	Content	Description
Page1		AC Voltage
Page2		AC Current
Page3		AC Power
Page4		Power Factor
Page5		AC Frequency
Page6		Total Power Consumption
Page7		Total Power Feed into Grid
Page8		Modbus Communication
Page9		8 Communication data position
Page10		Communication Address
Page11		Baud Rate



Note:

Don't press the button for long time, or you may change the default setting.

7. Connect the Smart Meter to Three-phase System

7.1 System Diagram

a. Three-phase System with TAPM-50KW Smart Meter

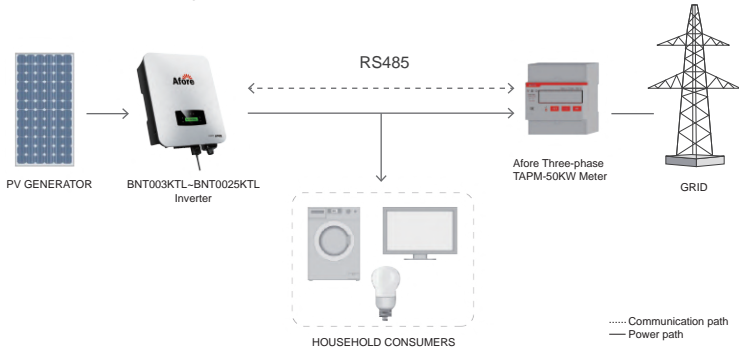

Note:

The 50kW smart meter does not support adding a CT

b. Three-phase System with TAPM-130KW Smart Meter

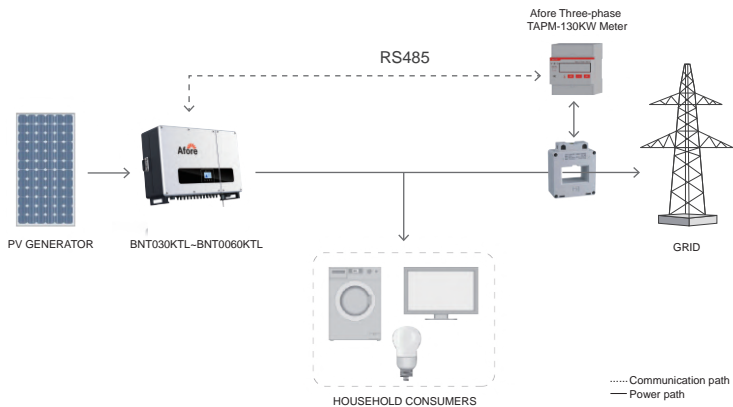

Note:

There are two faces P1&P2 on CT, P1 directs to Grid, P2 directs to inverter and load.

7.2 Three-phase 3-25kW Inverter Setting

Step 1

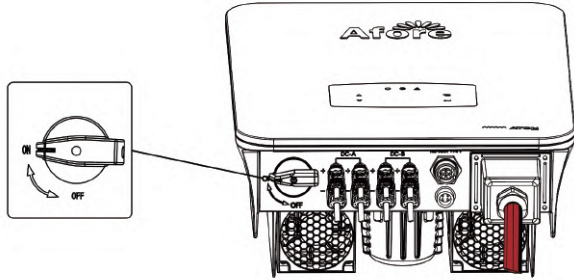

Step 2

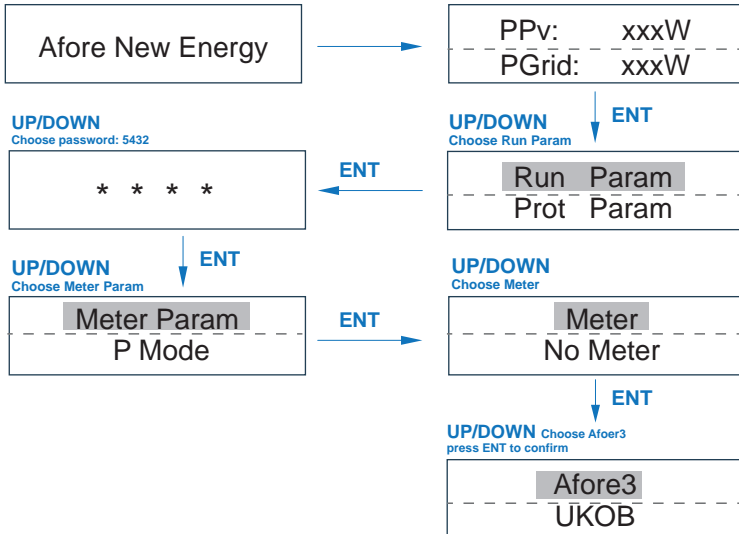

Step 3

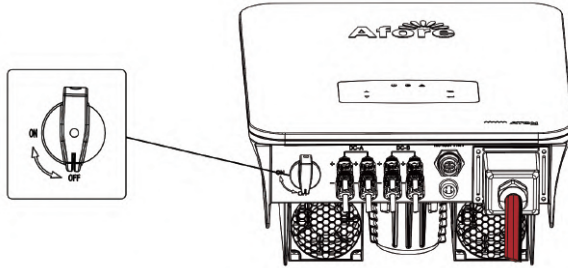

Note :

After activate "Meter" function, please restart the inverter.

7.3 Three-phase 30-60kW Inverter Setting

Step 1

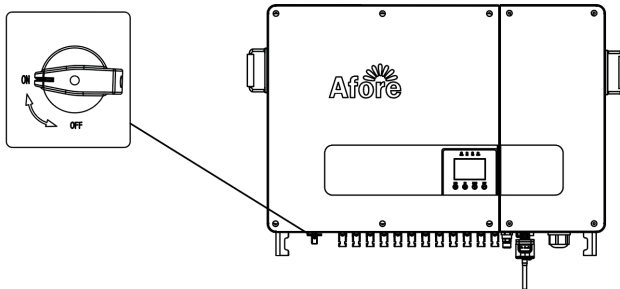

Step 2

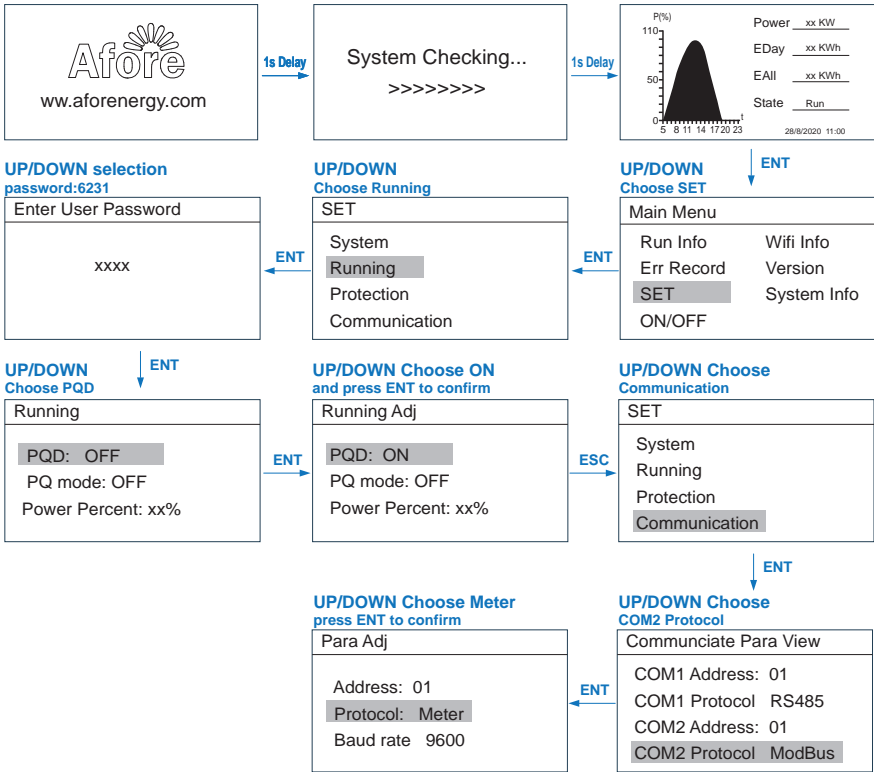

Step 3

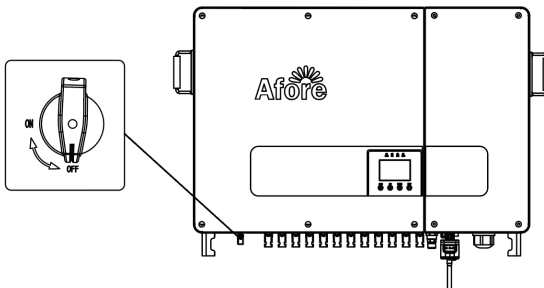

Note:
After activate "PQD"
function, please
restart the inverter.

7.4 Multiple Inverter System Connection Setting

a. For Three-phase 3-25kW Setting

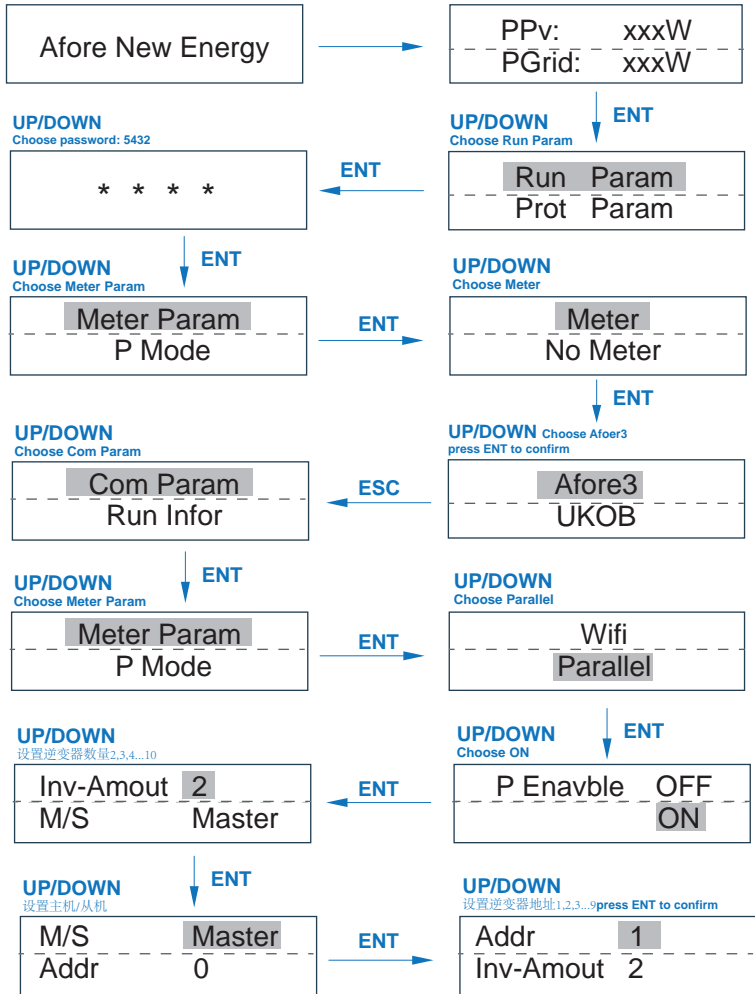

Note:

For the multiple-inverter system, set the Master inverter Addr address as 1, set the Salve inverter Addr address as 2, 3, 4... separately.

b. For Three-phase 30-60kW Setting

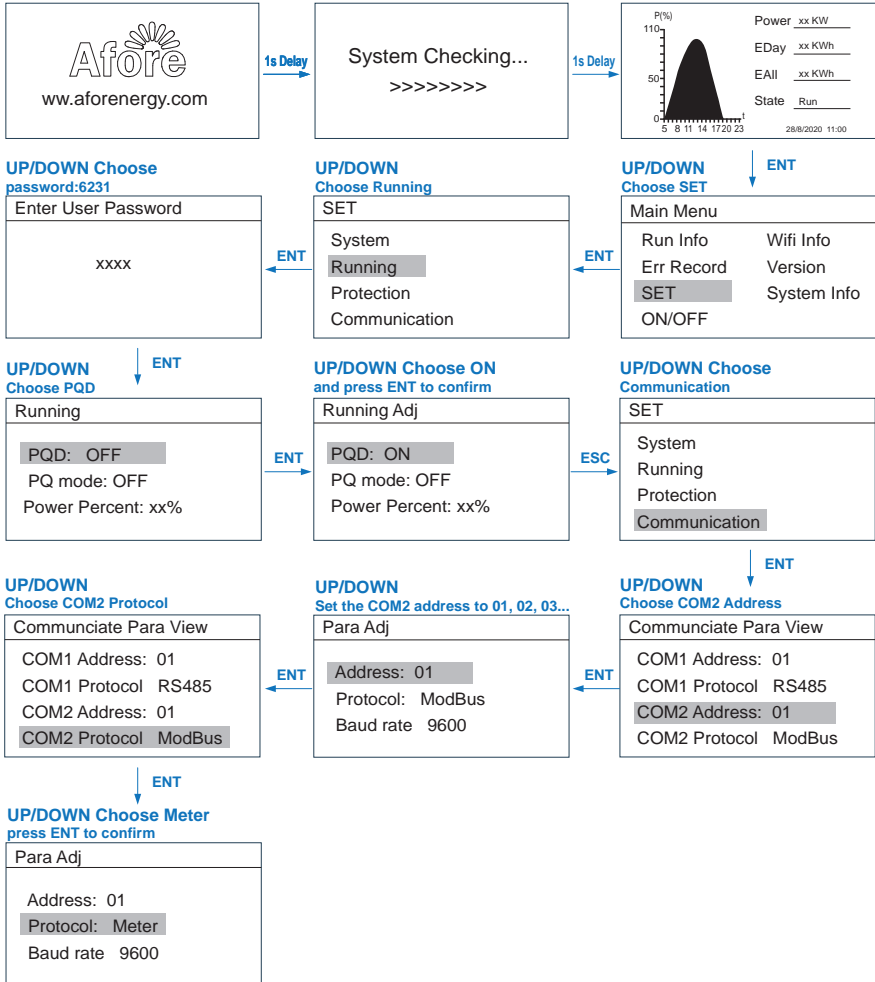

Note:

1. For the multiple-inverter system, set the Master inverter COM 2 address as 1, set the Salve inverter COM 2 address as 2, 3, 4... separately.
2. The total power of the inverters should not exceed 50kW (TAPM-50kW) / 130kW (TAPM-130kW).

7.5 Wiring Diagram

a. Three-phase Smart Meter (TAPM-50kW) Wiring Diagram

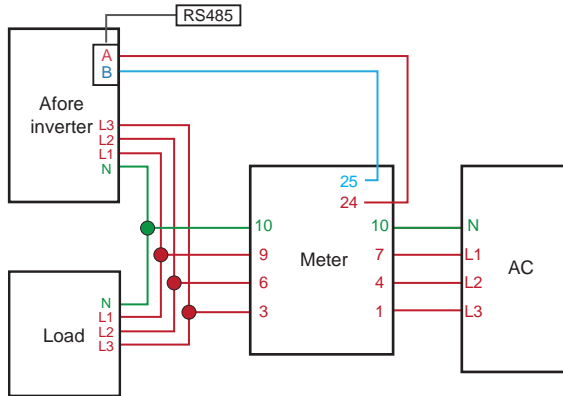

b. Three-phase Smart Meter (TAPM-130kW) Wiring Diagram

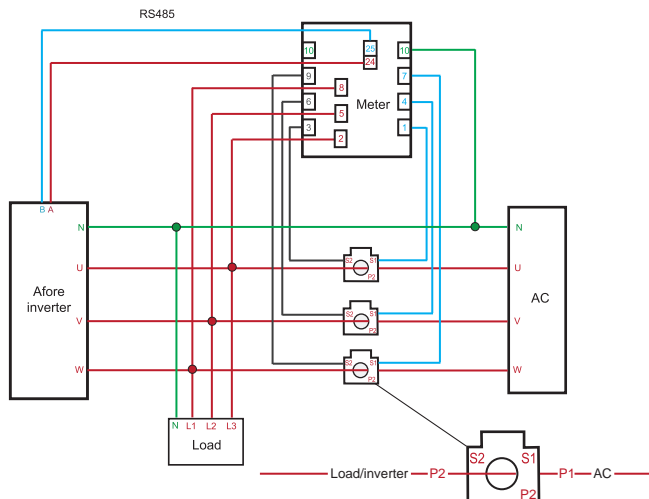

There are two faces P1&P2 on CT, P2 directs to inverter and load, P1 directs to AC.



Note :

1. The CT (30Φ 300/5A) should be used with the smart meter. For other types of CT, please confirm with dealer before use.
2. Pay attention to the indication install direction of the CT, otherwise the inverter will not work properly.

7.6 CT

Load capacity	CT secondary current	Current ratio	Accuracy	Passing heart turns
50/60KW	5A	200/5	0.5	1
100KW	5A	300/5	0.5	1
200KW	5A	400/5	0.5	1
300KW	5A	500/5	0.5	1
500KW	5A	1000/5	0.5	1
600KW	5A	1200/5	0.5	1
800KW	5A	1500/5	0.5	1
1MW	5A	2000/5	0.5	1
1.5WM	5A	3000/5	0.5	1
2MW	5A	4000/5	0.5	1

7.7 Current Ratio Setting

Buttons description: "SET" means "OK" or "Cursor shift" (when entering numbers), "ESC" means "Exit", "→" means "Add", when the number is added to the maximum value, The numbers will start from 0 again. The default user password is 701.

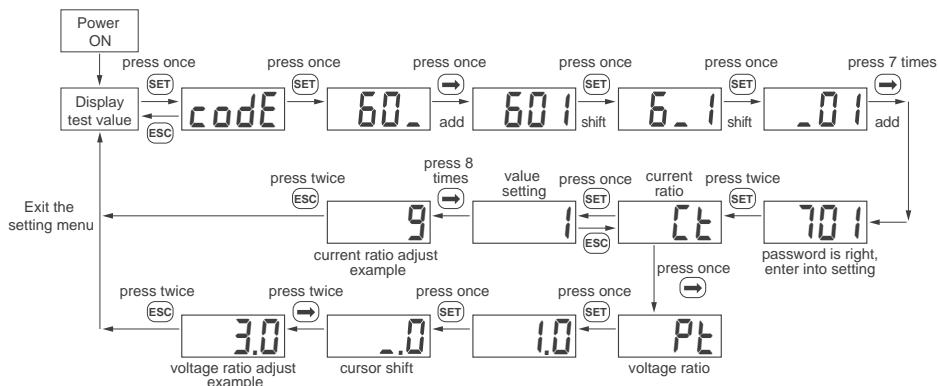

8. Three-phase Inverter Zero-Injection FAQ

8.1 Three-phase 3-25kW Zero-Injection FAQ

a. If the inverter operation normally and the smart meter wiring correctly, the phase active power value P_L display on the smart meter will be synchronize with inverter power (PGrid) value display.

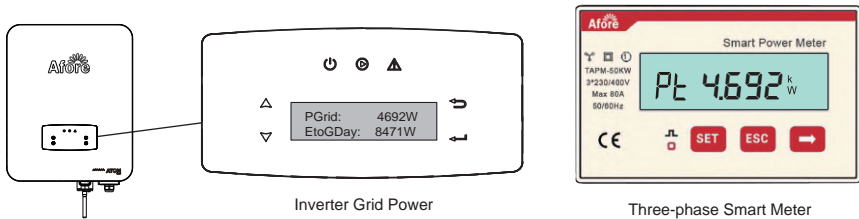

b. If the inverter running parameter (Running Param) is not selected as “Afore3” or faulty occurs to the communication line, it means the inverter and the smart meter are not in communication, the active power P_L on the smart meter is displayed normally, while the power of the inverter (PGrid) is displayed as 0W.

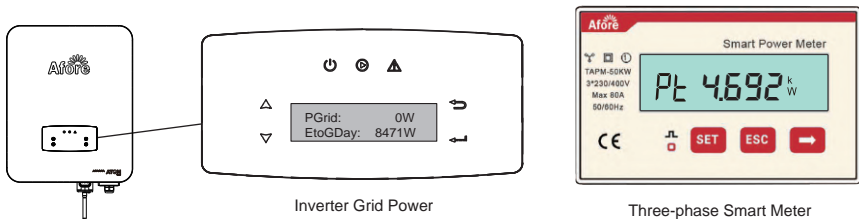

c. If ports 1/4/7/10 are incorrectly connected to the output ports of inverter, or the CT install direction is incorrect, the power on the smart meter P_L and the inverter (PGrid) will display negative values.

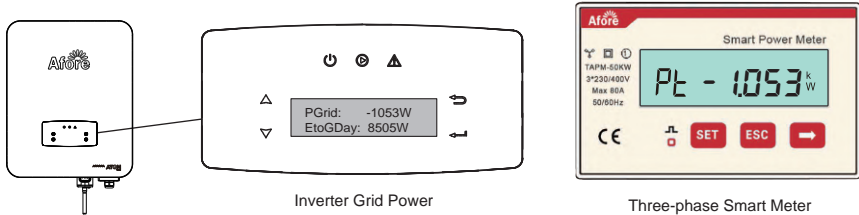

d. If wiring order of the three phases on the smart meter is incorrect, the current values of the three phases displayed on the smart meter will be different, the two phases that are incorrectly wiring will be smaller than the third phase.

- Current value of the two phases incorrectly wiring:
- Current value of the third phase:

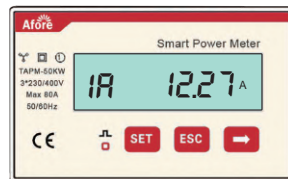
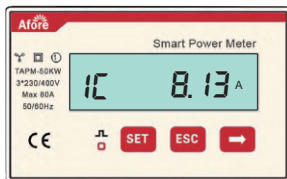

Note:

Due to the fluctuation on the grid side, the data transition delay will occur between smart meter and inverter. And the values displayed on the smart meter and inverter will be different.

8.2 Three-phase 30-60kW Zero-Injection FAQ

a. If the inverter operation normally and the smart meter wiring correctly. The total active power value P_L display on the smart meter will synchronize with inverter Total Pac ($P_a+P_b+P_c$) value display.

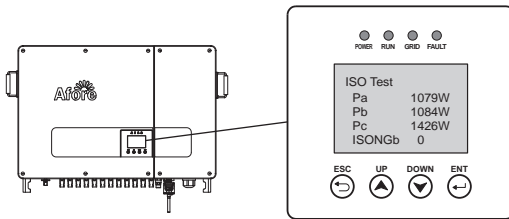

Inverter Pac ($P_a+P_b+P_c$)

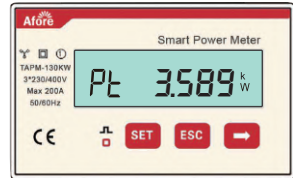

Three-phase Smart Meter

b. If the smart meter's pin wiring order is incorrect, the Smart Meter and the inverter Pac will be wrong display.

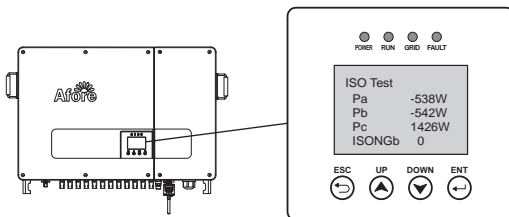

Inverter Pac ($P_a+P_b+P_c$)

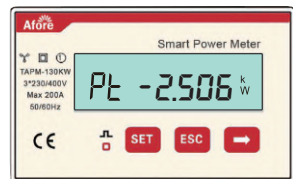

Three-phase Smart Meter

c. If the CT install direction is incorrect, the power on the smart meter and the inverter will display negative values.

d. If the CT wiring order is incorrect with smart meter, the power on the smart meter and the inverter will display negative values.

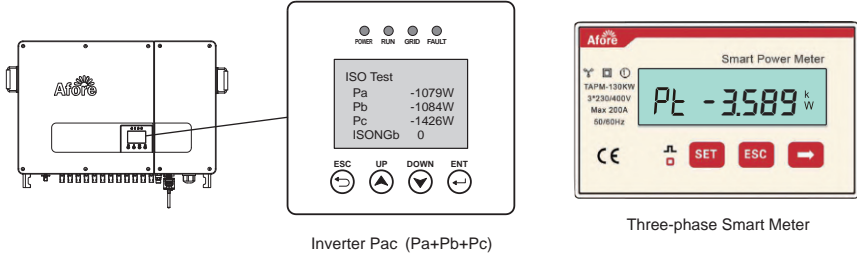



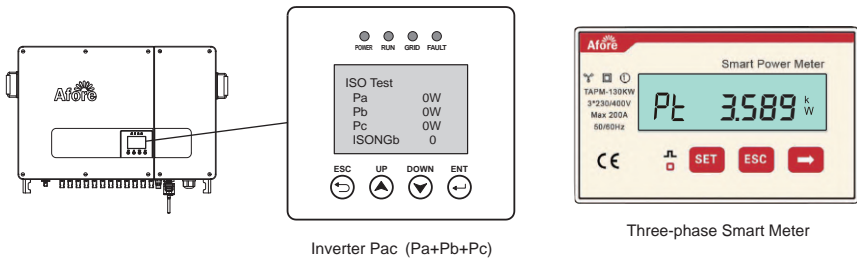









e. If the PQD function is not activated, COM 2 not setting or communication cable is not well connected, the power displayed on the inverter is $Pac=0W$.



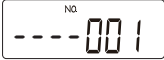

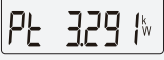

Note:

Do not connect the CT with port 10 of the meter, otherwise will lead short-circuit.

9. Explanation of Smart Meter Display Content

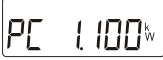
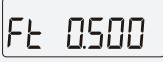
NUM	Display interface	Note
1		Total Active energy
2		Positive active energy
3		Reverse active energy
4		Communication Protocol
5		
6		Baud Rate
7		Communication address
8		Phase A Voltage
9		Phase B Voltage
10		Phase C Voltage
11		Phase A Current
12		Phase B Current
13		Phase C Current
14		Total power

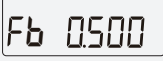
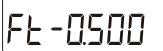
NUM	Display interface	Note
15		Phase A Power
16		Phase B Power
17		Phase C Power
18		Power Factor
19		Phase A Power Factor
20		Phase B Power Factor
21		Phase C Power Factor

10. Trouble Shooting

Fault	Reason	Solution
No display	<ul style="list-style-type: none"> · Wiring error · Supply voltage error 	<ul style="list-style-type: none"> · Please check the wiring · Please check the power supply voltage
Communication failure	<ul style="list-style-type: none"> · Communication line connection error · Communication cable failure · Zero Injection function not activate 	<ul style="list-style-type: none"> · Please reconnect the communication cable · Please replace the communication cable · Activate the zero injection function of the inverter and restart the inverter
Meter shows negative value	<ul style="list-style-type: none"> · Current transformer is not placed in the right direction · The smart meter is incorrect wiring 	<ul style="list-style-type: none"> · Please check the direction of the CT · Please reconnect the meter
The great discrepancy between the measured value and the actual value	<ul style="list-style-type: none"> · Wiring error · Voltage and current phase shifts are not the same 	<ul style="list-style-type: none"> · Please check the wiring · Please check the meter wiring